

Investigation of the Hysteretic Phenomena in RHEED Intensity Change in the Study of Surface Reconstruction

Ákos Nemcsics¹, Jenő Takács²

¹ Institute for Microelectronics and Technology, Óbuda University
Tavaszmező u. 17, H-1084 Budapest, Hungary;
Research Institute for Technical Physics and Materials Science
P.O.Box 49, H-1525 Budapest, Hungary
E-mail: nemcsics.akos@kvk.uni-obuda.hu

² Department of Engineering Science, University of Oxford
Parks Rd., Oxford OX1 3PJ, UK

Abstract: This paper describes a study of the RHEED intensity change against temperature in case of GaAs and InAs surfaces. RHEED as a technique is a widely used monitoring method for observing molecular-beam-epitaxial (MBE) growth. The reconstruction and other changes of the surface can be investigated by observing the RHEED pattern. Both the static and the dynamic RHEED-s are very complex phenomena, but these effects can be used as versatile tools for in-situ monitoring of the growth of the epitaxial layer, in spite of the fact that we do not know much about the details of its nature. Our observations showed that the specular beam intensity of RHEED had changed with the change of the surface temperature. We investigated the changes of the GaAs and InAs (001) surfaces by using this effect. The change in intensity follows the observed surface reconstruction. This change in the RHEED intensity against temperature shows hysteretic properties, with a different character for each material. So far, the explanations for these phenomena were different in both cases. Here, we explain these hysteretic phenomena in general terms with the $T(x)$ hyperbolic model for coupled hysteretic systems, which is applicable to both materials. Experimental results presented in the paper are in good agreement with the model predictions.

Keywords: RHEED; GaAs; InAs; hysteresis; surface reconstruction

1 Introduction and Experimental Preliminaries

The compound semiconductor structures grown by Molecular Beam Epitaxial (MBE) technology play an important role in the construction of semiconductor devices. Out of the compound semiconductors the most important group is the one III-V based. In this technology, the polar surfaces with (001) orientation are

fundamentally important. For the growth of low-dimensional nano structures it is vital to know the growth kinetics of the process. The MBE growth can be observed in-situ by monitoring the surface condition of the crystal (i.e. the surface reconstruction) by Reflection High-Energy Electron Diffraction (RHEED), which helps to understand the growth kinetics. In the case of exact and near layer-by-layer growth, the mostly observed surface reconstruction is (2×4) , although other surface reconstructions are also present. Earlier investigations have been done at constant temperature [1]. At a given temperature the ratio between As and the metallic component was changed and the surface construction was monitored [2]. The results of these experiments were presented in temperature versus reconstruction phase diagrams. We found that the phase limits are often ambiguous. We can extract further information by changing not only the ratio between As and the metallic component but also the temperature. By changing the temperature we observed a change in reconstruction and specular spot intensity variation. We also observed hysteresis in the intensity change of the specular spot against the changing temperature [3].

In the following we are going to investigate the changes in the behaviour of GaAs and InAs (001) surfaces against temperature variation, based on the experiments of Yamaguchi and Horikoshi [3]. This intensity variation against temperature shows hysteretic properties. During the experiment, the change in temperature was slow, so every point could be regarded as being in the state of thermal equilibrium. During the experiments, As₄ were used for the source of As. Shown by experimental results, the temperature dependence of the intensity of the specular spot depends neither on the incident azimuth angles nor on the energy of the electron beam [3]. We can say, therefore, that the intensity change of the specular spot is basically not the result of diffraction.

The RHEED specular spot intensity versus temperature diagrams are depicted in Fig. 1 and Fig. 2 for InAs and GaAs respectively. The results show that at lower temperature the specular spot intensity is high. With a raise in temperature the intensity gradually diminishes. Both in the case of GaAs and InAs, the surface at lower temperature shows arsenic-terminated (2×4) surface reconstruction. At higher temperature, however, In/Ga-terminated (4×2) surface reconstruction can be observed. The directional change of the temperature shows that the process is subject to hysteresis. In the case of both semiconductors tested, the observed hysteresis loops fall within approximately a 50 °C temperature range. In the case of InAs, we had two distinct hysteresis loops. At a lower temperature the observed wide loop is the indication of smaller intensity variation. At a higher temperature however we see a narrower loop with large and rapid intensity change. In the case of GaAs there is only one real loop at the lower temperature and a assumed degenerate pseudo loop at the higher temperature. In the second loop the ascending and the descending branches seemingly overlap. We will apply the general description of the phenomenon to both materials. In our present work we will consider two loops in both cases, giving a qualitative explanation for this

inverse spin-valve like, coupled loop structure. For the quantitative investigation we applied the $T(x)$ hyperbolic hysteresis model, developed for general description of hysteretic phenomena and which can be used to model other natural phenomena with hysteretic character, e.g. in biology, chemistry etc. [4]. It must be emphasized that although the RHEED intensity changes, due to MBE crystal growth, analyzed here, it is a non-magnetic process, and its character is analogous to and carries all the characteristic hallmarks of an inverse spin valve.

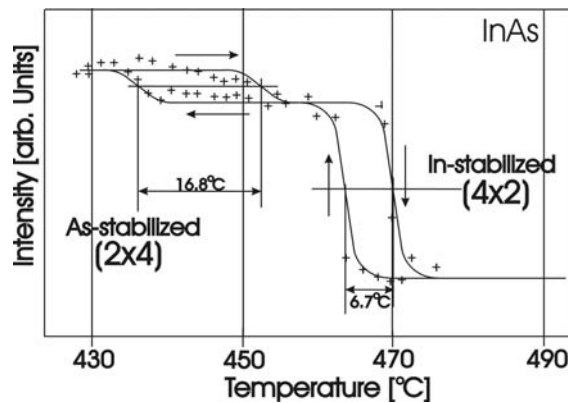

Figure 1

Temperature dependence of the specular beam intensity in the case of InAs (001) surface

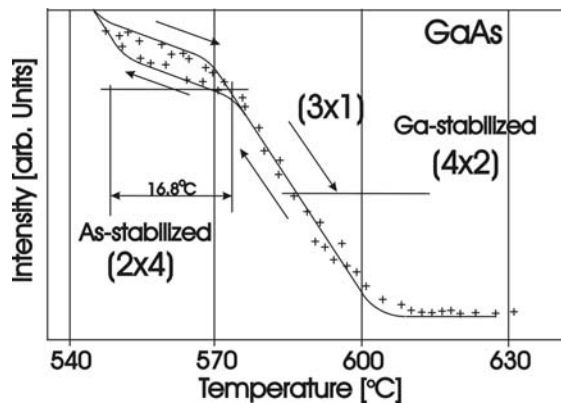

Figure 2

Temperature dependence of the specular beam intensity in the case of GaAs (001) surface

2 Discussion

2.1 Factors the Specular Spot Intensity of RHEED Depends on

As we know from the experimental results, the temperature dependence of the specular spot intensity is independent from the incidental and azimuth angles, as well as from the energy of the electron beam. This shows that it is not caused by diffraction but rather caused by a more complex phenomenon. The intensity of the specular spot also depends on the morphology of the surface. A surface with a perfect monolayer on top has high reflectivity, and therefore has a high specular spot intensity. The imperfect surface disperses the electrons, which results in a lower specular spot intensity. Changing temperatures cause the As components to leave the surface. This, by causing surface roughening, contributes to the lowering of the specular spot intensity, in addition to other causes nearly independent of diffraction. (The interaction between the electron beam and the surface, observed at a constant temperature, shows that the specular spot intensity is dependent on the incident and azimuth angle of the beam [1]. This is an indication that the diffraction also plays an important role in the process. When we observed the temperature dependence at fixed incident and azimuth angles, then we found the same relations [3]. The change in the angles was followed by the same pattern in the intensity change. From this we have concluded that specular intensity change versus temperature is not a diffraction phenomenon. The dispersion from the roughened surface is high and therefore the specular spot intensity will be low. With increasing temperature the crystal components begin to leave the surface, leaving a rougher surface behind.

The upper part of Fig. 3 depicts a simplified model of a semiconductor. Since the metallic component has a sticking coefficient near to unity ($S_{III} \sim 1$) it is expected that with higher temperature As will leave the surface. The incorporation of As takes place in three steps. The first step is the physisorption of the arsenic species, followed by the second, the dimerization of the arsenic to be finally chemisorbed in this form to the surface. The dimers will split at this third stage and the arsenic atom will finally be incorporated in the lattice. These processes represent three different energy levels. In our experimental temperature range, however, we only need to deal with the last two processes [5-12].

B. A. Joyce provided a graphic description of the RHEED specular spot intensity variation, resulting from the growth of layers, which leads to intensity oscillations following the growth layer by layer [13]. The starting point of this description is that the surface is perfect to begin with; therefore the reflection of the electron beam is high from the surface, resulting in high specular spot intensity. During the process of growth, crystalline seeds form, which in time grow into islands. When these islands coalesce, they then form a complete new surface. During growth, the initial surface loses its smoothness and becomes rougher. This results in larger electron dispersion and reduced specular spot intensity.

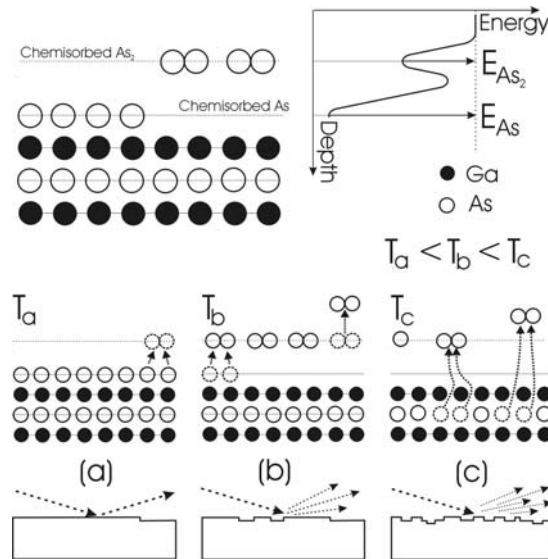

Figure 3

The chemisorbed As is incorporated in the surface in two stages. It is bound to the surface in the first stage in dimer and then in the second stage in atomic form.

The smooth surface gradually becomes rougher until it reaches maximum roughness, at which point it starts becoming smoother again. This change in surface morphology leads to specular spot intensity variation and eventually intensity oscillation. In spite of the simplicity of this model, it explains the decay of the RHEED intensity oscillation and confirms its quantitative description [14, 15]. The model of course is a gross simplification of the complex interaction between the electron beam and the surface. The specular spot intensity depends on the incidental angle and the electron beam direction, which is the cause of the phase shift of the intensity oscillation [16]. A number of researchers have already investigated and tried to explain this phenomenon [17-23]. The surface is always different from the bulk material because it tries to relax by getting to an energy minimum state and involving various surface reconstructions [24-31]. These reconstructions are dependent on the substrate temperature and the flux of the components. The reconstructions have very complicated phase diagrams. In first approximation there are two reconstruction phases to be considered. The first phase is when an As rich surface forms at a lower temperature and the second is when a surface, rich in Ga/In, forms at a higher temperature. In case of GaAs, the As rich formations are (2x4), c(2x8), C(4x4) or Ga-rich are (4x2), c(8x2), (6x6), (4x6). Between them there are transitory reconstructions such as (3x1), (1x6). Due to symmetry, one particular reconstruction may represent different atomic arrangements. For growing GaAs, the most widely used reconstruction is the $\beta_2(2x4)$, which in the direction of [-110] forms lines, made of As dimer pairs with trenches between them of depleted Ga. This surface is called As terminated after

this particular structure. During growth, this represents the perfect surface with maximum reflectivity, although the surface is obviously not flat. For the Ga induced growth the starting surface is (2x4), formed in an As atmosphere [14, 16] (see Fig. 4). As layers are grown one after the other, the surfaces of the successive layers become rougher, the oscillation decays and the secular spot intensity drops to minimum. In that case, the Ga rich surface shows (4x2) reconstruction [16]. Tempering of the surface, for maximizing intensity, is carried out by heat treatment in As atmosphere. With the increase of the secular spot intensity the (2x4) reconstruction reappears again [16]. The various surface reconstructions are associated with different surface stoichiometry, which is closely linked to the RHEED intensity. [32]. Although a large amount of information has already been compiled on the subject of surface reconstruction and its effect on the intensity and growth, there are still no acceptable comprehensive explanations of the phenomenon.

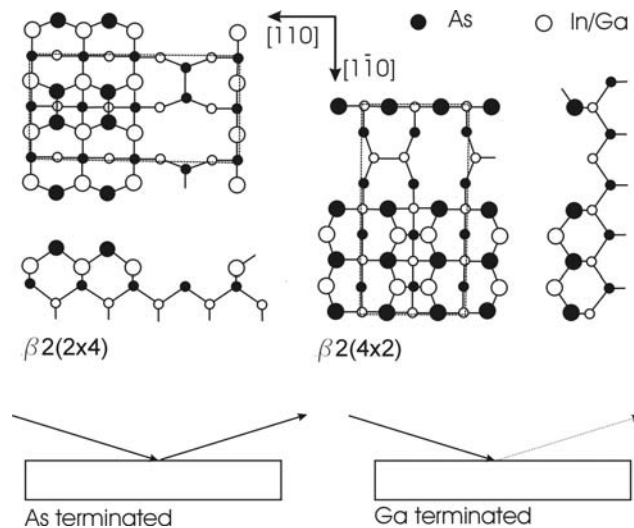

Figure 4

The surface reconstructions in As rich and in Ga rich cases. The relation between secular spot intensity and reconstruction. The reconstructed surface shows domain structure.

It is obvious that the explanation for the link between the roughened surface and the RHEED specular spot intensity covers only part of the truth. The surface, producing the maximum intensity, is not without imperfections, due to relaxation. At the same time the surface stoichiometry is changing all the time. A crystal surface with high content of As is associated with higher RHEED specular spot intensity, while a surface with high Ga/In content produces lower intensity. This is supported by observations of the phenomena at droplet-epitaxy, which shows that an As rich stripy RHEED picture becomes diffused, when the atoms of the Ga beam combine with the As atoms on the surface, they bind the Ga down and Ga settles on the surface [33].

As shown before, the specular spot intensity depends on the surface morphology and the surface construction. The increase in temperature causes primarily arsenic to leave the surface; therefore a perfect surface with high reflectivity is rich in arsenic. Any surface rich in metallic components has low reflectivity, disperses electrons and is the subject of droplet formation. Both the InAs and the GaAs crystallize in face-centered-cubic structure, with covalent binding, where four identical bindings can form due to sp^3 -hybridisation. The four equivalent bindings represent identical electron distribution in different directions. At the surface this symmetry breaks up and the surface relaxes. In the case of the arsenic terminated surface, the probability of the presence of the electrons is higher, due to the distorted electron distribution caused by the missing binding, perpendicular to the surface. When the surface is Ge terminated, then the effect is the opposite. The arsenic terminated surface becomes marginally negative, repelling the electrons, making the specular spot intensity higher. When, however, the surface is In/Ga terminated, then the electrons of the incident beam are neutralized and the specular spot intensity is reduced. The composition and also the morphology of the surface is linked to the surface reconstruction, and this reconstruction is the function of the temperature as well as of the arsenic pressure. The various reconstructions are periodically roughing up the surface.

2.2 Qualitative Description of the Chemisorption Induced Hysteresis in RHEED Intensity

As we said before, the specular spot intensity depends strongly on the surface stoichiometry. The high As coverage (less metallic components on the surface) represents higher intensity, whilst the low coverage of As represents lower intensity. In the intensity description we cannot disregard the effect of the surface morphology (see Section 2.3). The absorption-desorption phenomena in general always show hysteresis. The absorption-desorption depends on the state of the surface. Due to this dependence, the species bound at the surface, facing different conditions at the beginning, than later on when they leaving the surface towards the end of the process. This is of course true when the process is reversed. The absorption-desorption process of the materials falling into the III-V group is very complex.

The peculiar residing properties of the As, described in Section 2.1, has been the subject of investigation by a number of researchers using different methods [34-39]. In our case the As turned out to be in tetramer form (As_4). The As tetramer splits up on the arrival to the surface and settles in as one or two As dimmers, depending on the availability of free locations. Following that, it resides into its final location in the atomic state. The process is depicted in Fig. 5 where activation energy of the dimer is marked with E_{AS_2} , while the residing energy of As is represented by E_{As} . When the As is leaving the surface then the process is reversed. The As can leave the surface directly without going through the dimer state; therefore the two processes do not mirror each other.

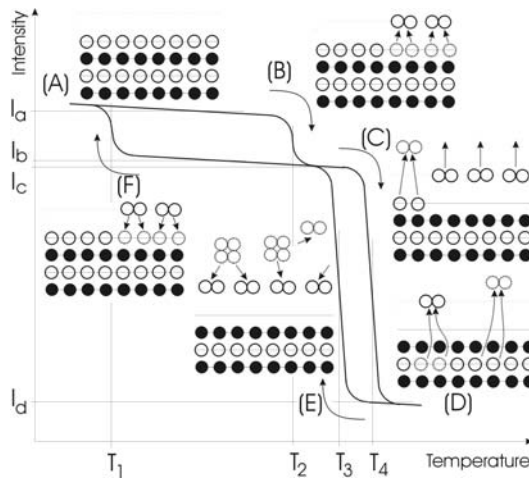

Figure 5

The qualitative explanation of the hysteresis in InAs with the absorption–desorption process

The roughening of the surface and the surface V/III ratio is closely linked during the heat treatment. The lower part of Fig. 3 shows this ratio change against temperature: In the case of (a): At low temperature (T_a) the surface is As terminated. The crystal surface is perfect to start with and the specular spot intensity is high. A small variation in the temperature changes the As at the surface to chemisorption 2 state or causes it to leave directly. This decomposition in the lower layers is less probable, and therefore the surface roughening is less likely. In the case of (b): Any further increase in temperature (T_b) chemisorbed As goes into chemisorption-2 state or leaves the surface. The layer of chemisorbed As tends to provide a shield against decomposition in the deeper layers. The departure of As from the deeper layers is less likely, so the roughing effect on the surface is small. As a result, the specular spot intensity will drop. In the case of (c): At high temperature the As coverage on the surface is zero; therefore likelihood of the surface decomposition will increase, since As can leave the crystal from the deeper layers as well. It results in further roughening of the surface and a drop in the specular spot intensity to minimum, due to Ga coming to the surface.

Let us consider the As surface coverage (Θ), the surface roughness and the change in the specular spot intensity as the function of the temperature for an idealized semiconductor surface. The As surface coverage can be the result of the presence of chemisorbed atomic As (Θ_c) or the arsenic dimer species (Θ_{c2}). In our model we will consider the near equal presence of the two form of As, in order to avoid further roughening of the surface. The resultant coverage therefore is the sum of the two coverages ($\Theta = \Theta_c + \Theta_{c2}$). Fig. 5 shows the intensity as a function of temperature. The curve follows the A-B-C-D path for increasing temperature, while it goes on the D-E-F-G path when the temperature decreases. Let us investigate now the surface in a few strategic places and the reason for the

hysteresis. In the state of (A) the temperature is low (T_1) and the As terminated surface reconstruction is (2×4) . The surface is perfectly smooth and the specular spot intensity is at maximum (I_a). Between (A) and (B) the temperature grows (T_1 - T_2), and therefore for the chemically bonded As atoms, it is more difficult to leave the As terminated surface, due to the strong bond. (E_{As}). The minimum loss of arsenic results in minimum loss surface roughening. As a result the drop in specular spot intensity is minimal ($\sim I_a$). Due to the high activation energy of chemisorption, a noticeable change in the surface condition can only be the result of a significant increase in the temperature. In the A-B region, therefore, no significant change will occur ($\Theta = \Theta_c$). It should be noted that the chemisorbed As sticking coefficient is dependent on the coverage ($S_{cAs}(\Theta)$), which explains the noticeable intensity drop in the A-B region. In stage (B) the chemisorbed arsenic species can convert into dimerized state in large quantities ($\Theta = \Theta_{c2}$). The arsenic coverage does not change significantly, and therefore the intensity only changes slightly. Between (B) and (C) the chemisorption state becomes vacant ($\Theta_c = 0$). In the (C) state and in the C-D range, small temperature variations can cause large sudden changes in the intensity. The dimer state can easily become vacant due to the low activation energy. The disappearance of most of the As from the surface represents a large change in the V/III ratio. As we have shown above this also results in a drop in the intensity of the specular spot (maximum surface roughness). The dimerisation sticking coefficient is a function of the coverage ($S_{c2As}(\Theta)$). In (D) the dimerized state becomes vacant (Θ_{c2}) and therefore the RHEED specular intensity is minimal.

Returning from (D) position, by reducing the temperature, the dimers start setting in at a lower temperature, marked (E), due to the fact that the setting in process for As is far more complicated than the process of leaving the surface. The dimers set in through the splitting of the tetramers, causing the hysteresis in the process. This is amplified by the shift, resulting from the recovery from the roughening of the surface. The second hysteresis loop has a similar explanation for the return leg.

2.3 Qualitative Description of the Reconstruction Induced RHEED Intensity Hysteresis

As we have shown before, the RHEED secular spot intensity has a strong relation to the surface stoichiometry. Less concentration of As and more metallic components represent higher, whilst the opposite brings lower spot intensity. In observing the intensity, however, we cannot neglect the surface morphology either. Generally speaking the absorption-desorption processes show hysteretic properties. The absorption-desorption depends on the state of the surface, therefore the species bound to the surface and leaving the surface first, face conditions substantially different to those leaving the surface last. This is applicable to the opposite process as well. The absorption-desorption processes of

the III-V materials are complex. The change in the secular spot intensity cannot be attributed entirely to the absorption-desorption process, although the surface coverage of As has a vital role in the phenomenon.

We can observe the change in the RHEED pattern during the temperature cycle. By observing a surface in quenched state through Atomic Force Microscopy (AFM) we can see that the surface is composed of domains of different states of reconstructions [30]. With changing temperature these domains will change their size at each other's expense. As a result, not only the distribution of the reconstructed domain will change but the composition map as well, all contributing to the change in the specular spot intensity.

Looking at the $I(T)$ diagram (see Fig. 1) of InAs, we can find two hysteresis loops. One is at lower, another one at higher temperature. In case of GaAs one loop exists at lower temperature, while the other is a single line, which however can be regarded as a degenerated loop (see Fig. 6).

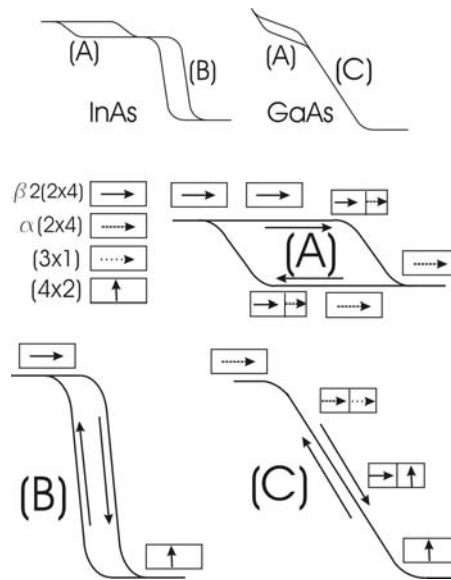

Figure 6

The qualitative explanation of the hysteresis in GaAs with the absorption –desorption process

Experimental evidence supports the view that in case of the higher temperature loop, the mid-temperature of the loop decreases with dropping As pressure, while its width increases at the same time. The experiments were carried out at different temperature settings but at the same pressure for both InAs and GaAs. It is quite possible that for GaAs, a second loop also exists at lower temperature. This leaves the question unanswered whether the comparison between GaAs and InAs was made at optimum conditions (temperature, As pressure, etc.) and how far these results are from optimum.

We saw that the $I(T)$ diagram has two hysteresis loops, and in both cases, if we regard one, in the case of GaAs, as a degenerate loop. It is evident that each of the loops corresponds to one different surface process and these processes are coupled to one another. A spin valve has similar characteristics. The loop at low temperature has higher intensity; therefore it is linked to surfaces with higher As content and processes. In both regions the RHEED indicates (2×4) type surface reconstructions. With the (1×1) surfaces, with no reconstruction, the dangling bonds are pointing in $[-110]$ direction [30].

The As rich reconstruction lines are forced to run in this direction. This surface symmetry can come in a number of reconstruction types: $\alpha(2 \times 4)$, $\alpha_2(2 \times 4)$, $\beta(2 \times 4)$, $\beta_2(2 \times 4)$, $\beta_3(2 \times 4)$, $\gamma(2 \times 4)$ [30]. The transformation of these domain structures into each other is the cause of the hysteresis loops. The (2×4) domain energy levels are very close to each other. The high As content $\beta_2(2 \times 4)$ type reconstruction forms first at lower temperature and this is followed gradually by the formations of the lower As content $\alpha(2 \times 4)$, $\alpha_2(2 \times 4)$ type domains. The $\beta_2(2 \times 4)$ type reconstructions are more stable than any of the previous ones, and therefore its lifetime is longer; it only transforms at higher temperatures and at a faster rate. This represents the upper part of the intensity curve. At decreasing temperatures, the reconstructions of low As content will materialize first, followed by the $\beta_2(2 \times 4)$ reconstruction at the appropriate temperature. Because it is a more favorable atomic arrangement it accelerates the dominant process on the surface. The path of the intensity curve will be different, forming the lower branch of the hysteresis loop. The changes are not only the result of the variation in the temperature but also of the delay caused by the transformation of the phases into one another. In other words, during the spontaneous transformations between equal energy states the stable states will stay; therefore the growth of the domains will not be dependant solely on temperature. (The transformation takes up energy). The loop at lower temperature for GaAs is similar to that of InAs, because the polar surfaces in both cases are solely determined by the behaviour of the As. The process around the loop of InAs at higher temperature (and the pseudo loop of GaAs) is determined mostly by the metallic component, so the difference is greater.

We can observe the (4×2) reconstruction at higher temperatures, where the dimmer lines of the In/Ga propagate in $[110]$ direction [39, 40]. It is obvious that for the InAs the $[110]$ direction represents the pinned structure, causing the As rich “hard” hysteresis. As the temperature increases the pinning is destroyed, the surface transforms quickly into an In rich (2×4) surface, resulting in a sudden intensity drop. This is what causes the double loop “soft” branch. The intensity change in this loop is much greater than in the previous one, because the sudden disappearance of the As, against the gradual drop in As before.

The procedure for GaAs is different. The As rich (2×4) reconstruction is followed by another As rich (3×1) reconstruction [32], which overlaps with the Ga rich (4×2) reconstruction. This is why we can assume the domain like transformations. The transformations here are not at all like those of the two state systems of InAs.

This is rather similar to the loop at lower temperature. Because the reconstructions here differ greatly energy wise as well as structurally, the speed up and the slow down effects of the domain interactions are not present. We can also assume that, the roughness of the surface plays an important role in the intensity change due to the varying structure and layering. It is possible therefore that the temperature sweep in both directions would result in the same intensity versus temperature curve.

2.4 Modeling of the Hysteresis in the RHEED Intensity

Although hysteresis has been known for a long time and well documented, coupled hysteretic systems spin-valves were only discovered forty years ago [41]. Its counterpart, the inverse spin-valve, is less than ten years old [42]. Although the phenomenon described in this paper is far removed from the physical mechanism of inverse spin-valves, its general character is strikingly similar. In general terms, the spin-valve effect involves two coupled hysteretic processes and is characterized by two hysteresis loops flowing into each other as the excitation varies periodically. Although there are a number of known models for describing hysteresis in magnetism, e.g. Preisach, Jiles, Stoner-Wohlfart, etc. [43-45], so far it is only the $T(x)$ hyperbolic model which can describe this rather complex phenomenon of two coupled hysteretic processes, forming a spin-valve character, on non magnetic terms [46]. The hyperbolic model has successfully been applied in several cases [47, 48].

The model is based on the Langevin's theory of ferromagnetism and well described in literature [41]; therefore here only a brief reminder will be given to the reader. For further information the reader is referred to the literature.

In the hyperbolic model each of the independent constituent components are identified and formulated by their separate hyperbolic functions. The components are separately analyzed and then linearly superimposed using Maxwell's superposition principle. The fundamental equations are shown in normalized canonic form:

$$y_{+n} = \sum_{k=1}^n (A_k f_{+k} + b_k) \quad (1)$$

$$y_{-n} = \sum_{k=1}^n (A_k f_{-k} - b_k) \quad (2)$$

$$b_k = \frac{A_k}{2} [f_{-k}(x_m) - f_{+k}(x_m)] \quad (3)$$

$$f_{\pm k} = \tanh \alpha_k (x \mp a_{0k}) \quad (4)$$

Here y is the RHEED specular spot intensity in normalized form, A is the intensity amplitude (maxima), v is the speed of the process or reaction, a_0 is the measure of the hysteresis, x_m is the maximum temperature swing used in the experiment and n is the number of components present in the process (for spin-valve like systems $n=2$ for both the ascending and the descending branch). The positive and the negative sign represent the ascending and the descending branch within a single loop respectively. In spin-valve like processes the two coupled loop has opposite hysteretic rotation, represented by the opposite sign of their a_0 parameter.

The model leads to the calculation of the activation energy of each of the constituent processes involved in the surface reconstruction. Following Boltzman's relations [49, 50] the activation energy involved in each leg of the hysteresis loop can be calculated as $\varepsilon = \alpha(x - a_0)kT$, where α is the inclination of the leg of the loop in K^{-1} , representative of the speed of the process or reaction at $x = a_0$ temperature (in K) including hysteresis, k is the Boltzman constant and T is the mid temperature of the processes in K [4, 51].

During calculations we assumed a linear relationship between the surface process and the RHEED specular spot intensity. In order to refine our results, presented here, further tests are planned to check the influence of the method of detection and the linearity of the instrumentation used, on the experimental results.

2.4.1 The Hysteretic Phenomenon in Case of InAs

The hysteresis in the RHEED specular spot intensity occurs between 425 °C and 475 °C for InAs surface. This temperature range is low relative to other substances like GaAs, indicating lower binding forces, supported by the lower thermostability [6]. With gradually increasing temperatures, the desorption of the As will increase, changing the ratio on the surface between As and the III/As in favour of the metallic component. It is known from observations that, during heat treatment, the As background will vanish and after a time a continuous layer of Ga will form on the surface. As a result the RHEED picture becomes diffused and the specular spot blends into the background [25]. The same happens when the surface is subjected to metallic flux without the presence of As. We can assume a strong relation between the intensity of the specular spot and the presence of the metallic substance in the upper surface layer. This is supported by the ongoing (2x4) and (4x2) reconstructions. Within the investigated temperature range there are two interactive hysteresis loops, as depicted in Fig. 7, showing the measured loop and the one predicted by the model. The parameter values (normalized and in physical units) used in the calculations, representing the best fit to the experimental data, are tabulated in Table 1. This table also includes the energies involved in the individual processes.

Table 1
The numerical parameters of InAs hysteresis loop calculated from the model

	Γ C	Amplitudes in arbitrary units		Speed of process normalized		Speed of process in $/C^0$ units		Hysteresis T normalised		Hysteresis T in C^0 units		Energy in eV	
		A_1	A_2	1	2	1	2	a_{01}	a_{02}	a_{01}	a_{02}	1	2
Up	440	1.5	0.2	25	17.5	0.4	0.28	0.25	-0.17	15.62	-10.65	-1.00	-0.24
Down		1.5	1.5	25	17.5	0.4	0.28	-0.1	0.65	-6.25	40.62	-0.76	0.26
Up	471.5	1.5	0.2	25	17.5	0.4	0.28	0.25	-0.17	15.62	-10.65	-0.16	0.381
Down		1.5	1.5	25	17.5	0.4	0.28	-0.1	0.65	-6.25	40.62	0.112	0.92

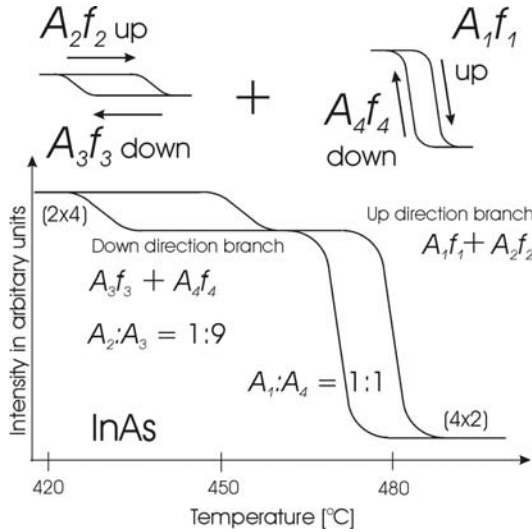

Figure 7

Measured and modeled InAs $I(t)$ loops showing the inverse spin-valve effect involving two coupled hysteretic processes, characterized by two hysteresis loops

This first successful modeling of the phenomenon has far reaching implications. The model predicts that there are two separable, simultaneous coupled processes taking place on the surface of InAs crystals at a given time. In one temperature cycle, in both cases, the up and down processes involves two single simultaneous physical processes, namely the surface morphology and the surface stoichiometry. Each of the four processes is described by one separate function in the model. In the phase of up-going temperature the dominant process is stoichiometric, representing nearly 85% of the RHEED intensity changes. The rest is due to the changes in morphology. However, when the temperature is decreasing, the

contributions of the two processes are equal (50%-50%). This finding strengthens the physical explanation given before and the results of the RHEED studies carried out on InAs.

2.4.2 The Hysteretic Phenomenon in Case of GaAs

The hysteresis in the RHEED specular spot intensity occurs between 545 °C and 610 °C for GaAs surface. This temperature range is higher than that of InAs, as shown before, indicating higher binding forces. The (2x4) and (3x1) surface reconstructions as well as the (3x1) and (4x2) dominating the process are the same as before for the InAs. This represents a temperature shift in the region where the same surface forces come into play at higher temperature. The first loop of 16.8 °C wide appears at the lower end of the range. The loop at higher temperatures is degenerative. This is a phenomenon which is not uncommon in the spin-valve character. The loop, predicted by the model, gives a good fit to the measured specular spot intensity versus temperature $I(T)$ curve as shown in Fig. 8.

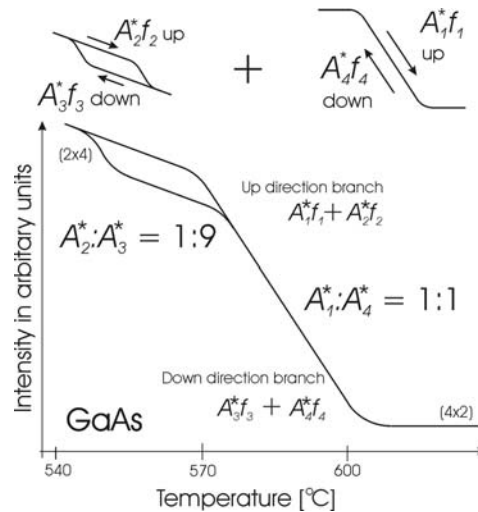

Figure 8

Measured and modeled GaAs $I(t)$ loops showing the inverse spin-valve effect involving two coupled hysteretic processes, characterized by two hysteresis loops

Although the model predicts the presence of a very narrow loop in the GaAs intensity plot at higher temperatures as well, its width is probably within the experimental error. It is interesting to note that while the physical parameters used in modeling are different for the two substances the approximate ratios between the amplitudes (A_n) remained nearly the same. This is a good indication that although the range of temperature shifted, the surface reactions are the same for the two experimental substances as we have initially assumed. The best fitting numerical parameters and the appropriate energy values are tabulated in Table 2.

Table 2
The numerical parameters of GaAs hysteresis loop calculated from the model

GaAs	T C°	Amplitudes in arbitrary units		Speed of process normalized		Speed of process in /C° units		Hysteresis ΔT normalised		Hysteresis ΔT in C° units		Energy in eV	
		A1	A2	$\alpha 1$	$\alpha 2$	$\alpha 1$	$\alpha 2$	a01	a02	a01	a02	$\epsilon 1$	$\epsilon 2$
Up	562	1.5	0.2	4	6	0.0246	0.037	0.1	0.1	16.21	16.21	-0.065	-0.108
Down		1.5	1.5	6	5.5	0.037	0.0339	0.52	0.1	84.32	16.21	0.0898	0.19
Up	588	1.5	0.2	4	6	0.0246	0.037	0.1	0.1	16.21	16.21	0.007	0.1
Down		1.5	1.5	6	5.5	0.037	0.0339	0.52	0.1	84.32	16.21	0.01	0.309

Conclusion

In former literature, the RHEED intensity variation in InAs as a GaAs has a completely different interpretation, attributed to different physical processes [1]. The one in InAs is described as a first order phase transition, whilst the one in GaAs is regarded as a second order phase transition. We propose in this paper that the driving force in this kind of surface phenomenon is the same for both of the investigated substances with only a different emphasis on its constituent components. The model predicted the presence of two hysteresis loops in both cases, showing the two processes involved. (At higher temperatures, in the case of GaAs the second loop is present but narrow or degenerate). The model describes in both cases with identical formulation using the same physical parameters with different numerical values. This shows a logical approach and points towards a unified way of describing the phenomena without introducing different interpretations in each individual case. We also pointed out that the double hysteresis loop is due to the absorption-desorption process and the changing, domain-structured surface morphology (surface reconstruction). The explanations, given for the intensity change, are the stoichiometry, polarization and surface roughness. We can distinguish between a soft and a hard loop, which also characterizes the spin-valve configuration. The constituent processes causing the double hysteresis loop (absorption-desorption and the changing reconstructions) affect the phenomenon in a different way when the temperature increases or decreases. The model showed that whilst the two processes play an equal role (approximately 1:1) when the temperature decreases, this ratio is substantially different (approximately 3:1) when the temperature is on the increase, due to the kinetics of As incorporation.

References

- [1] B. A. Joyce, J. H. Neave, J. Zhang, P. J. Dobson: RHEED Intensity Oscillations during MBE Growth of III-V Compounds; in Reflection High-Energy Electron Diffraction and Reflection Electron Imaging of Surfaces (Eds. P. K. Larsen and P. J. Dobson) Plenum Press, New York (1987) pp. 397-417
- [2] B. A. Joyce, D. D. Vvedensky: Quantum Dots in the InAs/GaAs System; in Quantum Dots: Fundamentals, Applications and Frontiers, Springer, Dordrecht (2005) pp. 1-26 (Eds.: B. A. Joyce, P. C. Kelires, A. G. Naumovets, D. D. Vvedensky)
- [3] H. Yamaguchi, Y. Horikosi: Surface Structure Transitions on InAs and GaAs (001) Surfaces; PRB, Vol. 51 (1995), pp. 9836-9854
- [4] J. Takács: Mathematics of Hysteretic Phenomena – The T(x) Model for the Description of Hysteresis; Wiley-VCH Verlag GmbH & Co, Weinheim (2003)
- [5] C. T. Foxon, B. A. Joyce: Interaction Kinetics of As₄ and Ga on (001) GaAs Surfaces Using Modulated Molecular Beam Technique; Surf. Sci. 50 (1975) 434-450
- [6] C. T. Foxon, B. A. Joyce: Interaction Kinetics of As₂ and Ga on (100) Surfaces; Surf. Sci. 64 (1977) 293-304
- [7] J. H. Neave, P. K. Larsen, J. F. van der Veen, P. J. Dobson, B. A. Joyce: Effect of Arsenic Species (As₂ or As₄) on the Crystallographic and Electronic Structure of MBE-Grown GaAs(001) Reconstructed Surfaces; Surf. Sci. 133 (1983) 267-278
- [8] Y. Fukunishi, H. Nakatani: Cluster Model Study on GaAs Epitaxial Crystal Growth by Arsenic Molecular Beam, As₂ Adsorption on GaAs Surface; Surf. Sci. 291 (1993) 271-280
- [9] E. S. Tok, J. H. Neave, F. E. Allegretti, J. Zhang, T. S. Jones, B. A. Joyce: Incorporation Kinetics of As₂ and As₄ on GaAs(110); Surf. Sci. 371 (1997) 277-288
- [10] E. S. Tok, J. H. Neave, J. Zhang, B. A. Joyce, T. S. Jones: Arsenic Incorporation Kinetics in GaAs(001) Homoepitaxy Revisited; Surf. Sci. 374 (1997) 397-405
- [11] R. Venkatasubramanian, V. K. Pamula, D. L. Dorsey: Influence of Physisorbed on RHEED Intensity Oscillations during Low-Temperature GaAs Molecular Beam Epitaxy; Appl. Surf. Sci. 104/105 (1986) 448-454

- [12] A. Suda, N. Otsuka: Surface Atomic Process of Incorporation of Excess Arsenic in Molecular-Beam Epitaxy of GaAs; *Surf. Sci.* 458 (2000) 162-172
- [13] B. A. Joyce; in *Two Dimensional Systems: Physics and New Devices*, G. Bauer, F. Kucher, H. Heinrich eds. (Springer Ser. In Solid State Sci. 67, Springer-Verlag, Heidelberg (1986)
- [14] Á. Nemcsics, J. Olde, M. Geyer, R. Schnurpfeil, R. Manzke, M. Skibowski: MBE Growth of Strained InGaAs on GaAs(001); *Phys. Stat. Sol. A* 155 (1996) 427-437
- [15] Á. Nemcsics: Behaviour of RHEED Oscillation during LT-GaAs Growth; *Acta Politechn. Hung.* 4 (2007) 117-123
- [16] B. A. Joyce, J. H. Neave, J. Zhang, P. J. Dobson: RHEED Intensity Oscillation during MBE Growth of III-V Compounds; in *Reflection High-Energy Electron Diffraction and Reflection Electron Imaging of Surfaces*; NATO ASI Ser. 188, Plenum Press New-York (1988) 397-417
- [17] W. Braun, L. Däweritz, K. H. Ploog: Origin of Electron Diffraction Oscillations during Crystal Growth; *Phys. Rev. Lett.* 80 (1998) 4935-4938
- [18] W. Braun: *Applied RHEED, Reflection High-Energy Electron Diffraction during crystal growth*; Springer-Verlag, Berlin (1999)
- [19] Z. Mitura, S. L. Dudarev, M. J. Whelan: Phase of RHEED Oscillations; *Phys. Rev. B* 57 (1998) 6309-6312
- [20] Z. Mitura: Interactive Method of Calculating Reflection High-Energy-Electron-Diffraction Intensities; *Phys. Rev. B* 59 (1999) 4642-4645
- [21] Z. Mitura, S. L. Dudarev, M. J. Whelan: Interpretation of Reflection High-Energy Electron Diffraction Oscillation Phase; *J. Cryst. Growth* 198/199 (1999) 905-910
- [22] J. M. McCoy, U. Korte, P. A. Maksym, G. Meyer-Ehmsen: Multiple Scattering Evaluation of RHEED Intensities from the GaAs(001)-(2x4) Surface; *Phys. Rev. B* 48 (1993) 4721-4728
- [23] Á. Nemcsics: The Initial Phase Shift Phenomenon of RHEED Oscillations; *J. Cryst. Growth* 217 (2000) 223-227
- [24] Q.-K. Xue, T. Hashizume, T. Sakurai: Scanning Tunneling Microscopy of III-V Compound Semiconductor (001) Surface; *Prog. Surf. Sci.* 56 (1997) 1-137
- [25] M. Witte, G. Meyer-Ehmsen: RHEED Structure Analysis of the GaAs(001)2x4 Surface for Azimuths [110] and [010]; *Surf. Sci.* 326 (1995) L449-L454

- [26] J. M. McCoy, U. Korte, P. A. Maksym: Determination of the Atomic Geometry of the GaAs(001)2x4 Surface by Dynamical RHEED Intensity Analysis: the $\beta 2(2 \times 4)$ Model; Surf. Sci. 418 (1998) 273-280
- [27] F. Bastimann, A. G. Cullis, M. Hopkinson: GaAs(001) (2x4) to c(4x4) Transformation Observed in-situ by STM during As flux Irradiation; Surf. Sci. 603 (2009) 2398-2402
- [28] K. Shiraishi, T. Ito: Atomic and Electronic Structures of Surface Kinks on GaAs(001) Surfaces; Appl. Surf. Sci. 121/122 (1997) 98-101
- [29] S. Tsukamoto, N. Koguchi: Magic Numbers in Ga clusters on GaAs(001) Surface; J. Cryst. Growth 209 (2000) 258-262
- [30] A. Ohatke: Surface Reconstruction on GaAs(001); Surf. Sci. Rep. 63 (2008) 295-327
- [31] B. A. Joyce, D. D. Vvedensky: Self-organized Growth on GaAs Surfaces; Mat. Sci. Eng. R 46 (2004) 127-176
- [32] C. Deparis, J. Massies: Surface Stoichiometry Variation Associated with GaAs (001) Reconstruction Transitions; J. Cryst. Growth 108 (1991) 157-172
- [33] Á. Nemesics, Ch. Heyn, A. Stemmann, A. Schramm, H. Welsch, W. Hansen: The RHEED Tracking of the Droplet Epitaxial Grown Quantum Dot and Ring Structures; Mat. Sci. Eng. B (2009) in press
- [34] J. F. van der Veen, L. Smir, P. K. Larsen, J. H. Neave: Core Level Binding Energy Shift for Reconstructed GaAs(001) Surfaces; Physica B 117 (1983) 822-824
- [35] C. Sasaoka, Y. Kato, A. Usui: Temperature Programmed Desorption Study of GaAs(100)-c(4x4) and As₄ Exposed (2x4) Surfaces; Surf. Sci. Lett. 265 (1992) L239-L244
- [36] R. Kaspi, S. A. Barnett: Analysis of GaAs(001) Surface Stoichiometry using Monte Carlo Simulations; Surf. Sci. 241 (1991) 146-156
- [37] I. Chizov, G. Lee, R. F. Willis, D. Lubysev, D. L. Miller: Scanning Tunneling Microscopy Study of the Evolution of the GaAs(001) Surface during the (2x4)-(4x2) Phase Transition; Appl. Surf. Sci. 123/124 (1998) 192-198
- [38] M. Larive, G. Jezequel, J. P. Landesman, F. Soal, J. Nagle, B. Lépine, A. Taleb-Ibrahimi, G. Indelkofer, X. Marchadet: Photoelectron Spectroscopy Study of Ga 3d and As 3d Core Levels on MBE-Grown GaAs Surfaces; Surf. Sci. 304 (1994) 298-308

- [39] J. Behrend, H. Wassermeier, K. H. Ploog: Different As Desorption Behaviour at Steps Edges on InAs(001) and GaAs(001) Surfaces; *Surf. Sci.* 372 (1997) 307-311
- [40] I. Chizov, G. Lee, R. F. Willis, D. Lubisev, D. Miller: Scanning Tunneling Microscopy Study of the Evolution of the GaAs(001) Surface during the (2x4)-(4x2) Phase Transition; *Appl. Surf. Sci.* 123/124 (1998) 192-198
- [41] J. Takács: A Phenomenological Matematical Model of Hysteresis; *COMPEL Int. J. Comp. El.* 20 (2000) 2002-2014
- [42] L. K. Varga, Gy. Kovacs, J. Takacs: Modelling the Overlapping, Simultaneous Magnetization Processes in Ultrasoft Nanocrystalline Alloys; *J. Magnetism & Magn. Mat.* 320 (2008) L26-L29
- [43] F. Preisach: Über die magnetische Nachwirkung; *Z. Phys.* 94 (1935) 227-230
- [44] D. C. Jiles, D. L. Atherton: Theory of Ferromagnetic Hysteresis; *J. Appl. Phys.* 55 (1984) 2115-2119
- [45] E. C. Stoner, E. P. Wohlfarth: Hysteresis Modeling of Recording Media with as Interacting; *IEEE Trans. on Magn.* 27 (1991) 3475-3479
- [46] J. Takács, I. Mészáros: Separation of Magnetic Phases in Alloys; *Physica B* 403 (2008) 2293-2297
- [47] I. Mészáros: Magnetic Characteization of Phase Transformations in Trip Steels; *J. El. Eng.* 59 (2008) 1-4
- [48] I. Mészáros: Hyperbolic Model Based Data Evaluation for Magnetic NDE Measurements; *Mat. Sci Forum* 589 (2008) 251-256
- [49] L. Boltzman: *Vorlesungen über Gastheorie*; J. A. Burth, Leipzig, (1896)
- [50] E. H. Kennard: *Kinetic Theory of Gases*; McGraw-Hill, New York (1938)
- [51] J. Takács: Energy Consideration of the T(x) Model of Hysteresis; *COMPEL Int. J. Comp. El.* 24 (2005) 220-228