

# Energetic Utilisation of Pyrolysis Gases in IC Engine

**Viktória Barbara Kovács, Attila Meggyes**

Department of Energy Engineering, Faculty of Mechanical Engineering, BME,  
Műgyetem rkp. 3, H-1111 Budapest, Hungary  
kovacsv@energia.bme.hu, meggyes@energia.bme.hu

---

*Abstract: The use of alternative energy sources like pyrolysis gases as a source of renewable energy for combined heat and power generation could provide an effective and alternative way to fulfil remarkable part of the increasing energy demand of the human population as a possible solution of decentralized power generation. Therefore the role of utilization of pyrolysis gases rapidly grows in Europe and all around the world. The energetic utilization of these low heating value renewable gaseous fuels is not fully worked out yet because their combustion characteristics significantly differ from natural gas, and this way they are not usable or their utilization is limited in devices with conventional build-up. At the Department of Energy Engineering of BME the IC Engine utilization of pyrolysis gases was investigated. The power, efficiency, consumption and exhaust emission were measured and indication was made to determine the pressure and heat release in the cylinder at different engine parameters.*

*Keywords: renewable, pyrolysis gas, IC engine, power, efficiency, indication, heat release, exhaust emission*

---

## 1 Introduction

This paper is focusing on the investigation of combustion characteristics of pyrolysis gases from the aspect of energetic utilization. The utilization of renewable alternative energy sources like liquid bio-fuels [1], [2] biogases and pyrolysis gases will have a major role in mitigating the climate change while the increasing energy demand of the humanity need to be fulfilled and the sustainable development should be maintained. Because renewable energy sources, among them bio- and pyrolysis gases used in CHP units could be an effective alternative to fulfil remarkable part of this energy demand as a possible solution of decentralized power generation because the total efficiency of a gas engine operated in cogeneration or trigeneration can be more than 90%. [3], [4]. Therefore the role of utilization of renewable gaseous fuels rapidly grows in Europe and all around the world. The renewal's share of the total energy sources

is below the expected in Hungary so not only the utilisation of biogases but the utilisation of other renewable gaseous fuels such as pyrolysis gases is recommended.

However several investigation was made to determine the combustion characteristic of these pyrolysis gases operating in various heat engines [5], [6], [7], but their energetic utilization is not fully worked out yet because of their different composition their combustion characteristics significantly differ from those conventional fuels like natural gas or PB gas [3], which are already used for power generation. So pyrolysis gases are not usable or their utilization is limited in heat engines with conventional build-up.

Therefore the energetic utilization of pyrolysis gases in IC engine with conventional build-up is problematic if their inert or hydrogen content is high. Therefore measurements were made to determinate the effect of the different composition, especially the high H<sub>2</sub> content of pyrolysis gases on the operation of IC Engine with conventional build-up at the Department of Energy Engineering – BME.

## 2 Properties of Pyrolysis Gases

The combustion characteristic of these renewable fuels differs from natural gas due to their different composition. The difference of pyrolysis gases and biogases it that biogases contain mainly CH<sub>4</sub> and CO<sub>2</sub> and an irrelevant amount of N<sub>2</sub>, H<sub>2</sub>, CO and SO<sub>2</sub>, but pyrolysis gases beside CH<sub>4</sub> and CO<sub>2</sub> mainly contain CO and H<sub>2</sub> an depending on the production technology high amount of N<sub>2</sub>. The LHV of these gases is low due to their high inert and /or high hydrogen content because the LHV per volume of hydrogen is much lower than the LHV of methane (Table 1). In case of gaseous fuel the LHV per volume is more important because the IC engine has constant mixture volume intake.

Table 1  
LHV of hydrogen and natural gas

	Hydrogen	Natural gas
LHV [MJ/kg]	119.9	50.03
LHV [MJ/Nm <sup>3</sup> ]	10.78	35.9

For modelling the combustion quality of pyrolysis gases three different trial gas mixtures were determined, because the composition and the quality of pyrolysis gas mainly depends on its production technology. Pyrolysis gases can be gasified with outer heat source or with inner heat source, which could be air or pure oxygen. The H<sub>2</sub>O content of these trial gas mixtures was neglected during the calculations and measurements, because it can be easily separated from the other components.

Table 2  
Content and properties of different pyrolysis gases

component [V/V%]	“natural gas”	pyrolysis gases		
		outer heat source	inner heat source	
			air	oxygen
		“anaerobe pyrolysis gas”	“producer gas”	“synthesis gas”
CH <sub>4</sub>	100	8	5	3
H <sub>2</sub>	0	38	20	40
CO	0	20	20	40
CO <sub>2</sub>	0	20	5	17
N <sub>2</sub>	0	14	50	0
LHV [MJ/m <sup>3</sup> ]*	35.90	9.49	6.47	10.44
Wo [MJ/m <sup>3</sup> ]*	53.66	12.61	7.94	13.68

\* calculated at 273 K and 101325 Pa

Apart from the LHV, the Wobbe number is a crucial parameter as far as combustion process of gaseous fuels is concerned, because it shows the changeability of gaseous fuels. By the changing of the gas composition the Wobbe number and accordingly the heat load of the combustion equipment changes too. The Wobbe number of these renewable gases significantly differs from the natural gas; therefore it is clear that the utilization of these renewable gases needs several investigations. [8]

From the point of view of stable operation of the engine the variation of these two parameters should be kept in the range of  $\pm 5\%$  it is obvious that neither the LHV nor the Wobbe number can be kept in the required range in case of pyrolysis gas operation.

According to previous investigations gas type “producer gas” was chosen to do the measurements on IC engine, because the usual pyrolysis gas production technology is gasification with air as an inner heat source.

The combustion characteristic of “producer gas” differs from natural gas. The H<sub>2</sub> content of “producer gas is quite high, which is critical from the point of view of knock, and it has very low LHV which is critical from the point of view of power. Due to the high H<sub>2</sub> content of “producer gas” the direct use in IC engine was not recommended therefore the “producer gas” was mixed to natural gas. The combustion properties of these fuel mixtures was investigated. In case of the calculations the natural gas was modelled by pure methane gas, because the natural gas type “D” that is provided in Hungary contains more than 98 V/V% methane.

Theoretical calculation were made with CHEMKIN 4.0 software - GRI 3.0 mechanism, which is a reduced mechanism for modelling methane combustion and is capable for modelling the combustion of CO, H<sub>2</sub> and the formation of NO<sub>x</sub>

too. Therefore it is capable for modelling the combustion of pyrolysis gases. The two most important combustion parameters were calculated: the adiabatic flame temperature ( $T_{ad}$  [K]) and the laminar flame velocity ( $u$  [cm/s]). The effect of the admixed “producer gas” was investigated on these combustion parameters.

The “producer gas” has lower adiabatic flame temperature than natural gas, but the laminar flame velocities of “producer gas” and natural gas are quite the same in the operation range of a gas engine. Therefore by the increasing “producer gas” content of the fuel mixture the adiabatic flame temperature decreases, but the change of the laminar flame velocity is not relevant, because it do not exceeds  $\pm 2\%$  of the laminar flame velocity of natural gas. But it slightly decreases until 40% “producer gas” content and above it increases until 90% “producer gas” content (Figure 1). [11]

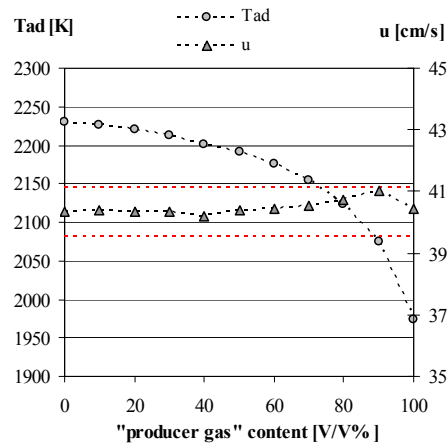

Figure 1

Calculated adiabatic flame temperature and laminar flame velocity against “producer gas” content at  $\lambda=1$ , 273 K, 10135 Pa

Two dimensionless factors were defined to determine the effect of the “producer gas” content of fuel mixture on the combustion properties [9]. The LHV ratio ( $\gamma$ ) shows how many times higher the LHV of natural gas is compared to “producer gas – natural gas mixtures.

The next dimensionless factor, the theoretical fuel-air mixture volume ratio ( $\epsilon$ ) shows how many more times biogas can be used compared to natural gas to keep the excess air ratio of 1 m<sup>3</sup> fuel - air mixture constant.

The value of these two factors ( $\gamma$ ,  $\epsilon$ ) depends on “producer gas” content of the fuel mixture. If the LHV ratio ( $\gamma$ ) and the theoretical fuel-air mixture volume ratio ( $\epsilon$ ) are equal at a given “producer gas” content, the LHV decrement caused by the low LHV of “producer gas” can be equalized by the increasing fuel proportion of the fuel-air mixture.

Figure 2 shows that the values of  $\gamma$  and  $\varepsilon$  are nearly the same until 50 V/V% “producer gas” content, but above it the decrement of LHV is higher than the possible increment of the air-fuel mixture volume flow so the effect of the decreasing heating value could not be equalized. This phenomenon was confirmed by the following measurements.

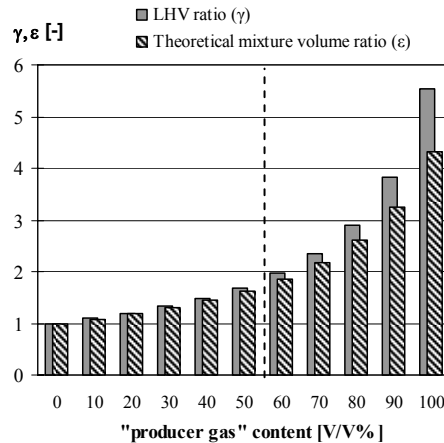

Figure 2

LHV- and theoretical fuel-air mixture volume ratios of different “producer gas” – natural gas mixtures calculated at 273 K and 10135 Pa

### 3 Experimental Set-up

Measurements were made at the laboratory of the Department of Energy Engineering of BME to determine the combustion characteristic of biogases on a BAG-30 gas engine unit which was modified for laboratory measurements (Figure 3).

The “producer gas” was modelled by a trial gas mixture that was ordered from Linde Gas Hungary in a bundle and was mixed through a multistage pressure regulator to the natural gas and the mixture was aspirated by the engine. The homogenization of the mixture was prepared in a mixing unit. The composition of the mixture was controlled with a  $\text{CH}_4$  analyzer.

The control of the gas engine was made with the asynchronous generator of the engine. The constant speed was provided by a frequency inverter which was connected to the asynchronous generator. The electric power was measured with the frequency inverter. During the measurements intake pressure was kept at a constant value.

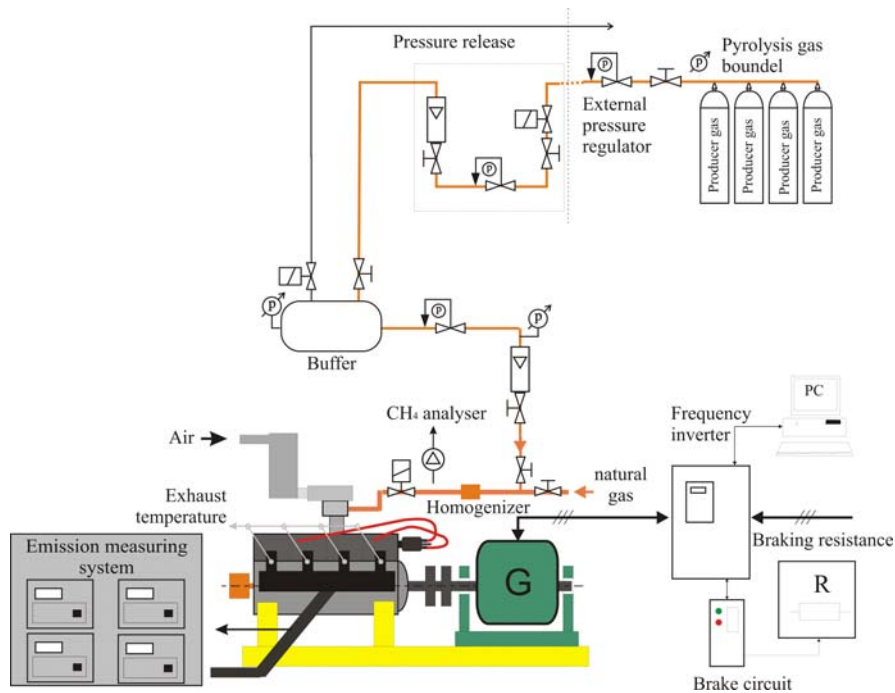

Figure 3  
Build-up of the measuring system

The evolved pressure was measured with a piezo pressure transducer in a Kistler 6517-A spark plug which was installed in the 1<sup>st</sup> cylinder of the engine. Test series consist of 100 combustion cycles with sampling rate of 1024 per cycle and were averaged by statistical methods.

The gross heat release in the cylinder was calculated from the combustion pressure with a software which was developed at the Department of Energy Engineering [10].

The emissions of the gas engine were measured with a Horiba MEXA-8120F emission measuring system. The oxygen content of the exhaust gas which was needed for the determination of the excess air ratio ( $\lambda$ ) was measured by a SERVOMEX 570A oxygen analyzer. The measured data of the engine was recorded by electronic data collection system.

The reference measurements were made with natural gas (0 V/V% “producer gas” content). The measurements were made at 10; 20; 30; 40; 50 and 60 V/V% “producer gas” contents. At higher “producer gas” content the operation of engine become unstable, so with higher than 60 V/V% “producer gas” content measurement could not be made. The impact of the increasing “producer gas” content was investigated on the engine parameters: power, efficiency,

consumption, and emission. Due to the comparability and reproducibility the measurements were made at constant spark timing, speed and intake pressure in case of several excess air ratios.

## 4 Results

From the point of view of engine operation the in-cylinder peak pressure is very important parameter (Figure 4), because it affects the power of the engine.

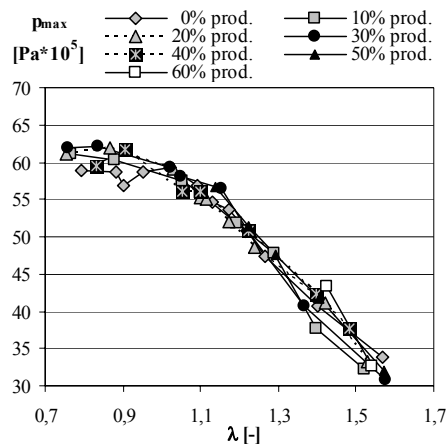

Figure 4

Measured maximum pressures in the cylinder against excess air ratio

It is observable that the peak pressures are quite the same by increasing “producer gas content of the fuel mixture, but the operation range of the engine narrows as well. Namely in case of 50 V/V% “producer gas the operation range is only the half of the operation range of the reference measurement and it is shifted to leaner mixtures. In case of 60 V/V% “producer gas under  $\lambda=1.4$  measurements could not be made, because the operation of the engine was unstable.

In order to compare the form of the cylinder pressures Figure 5 shows the normalized measured pressures in the cylinder at constant excess air ratio ( $\lambda=1.4$ ). It is observed that neither relevant change of the peak pressures nor relevant shift of the peak pressure from the TDC (which was adjusted to 360 degree) could be experienced.

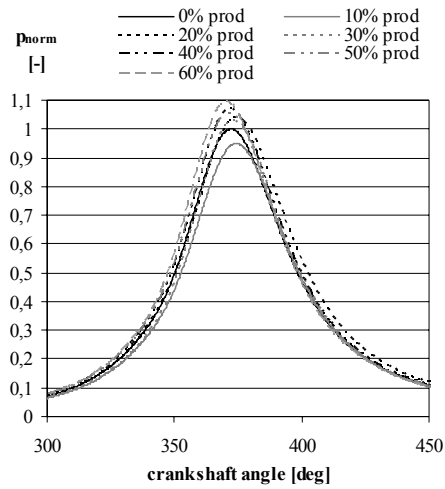

Figure 5

Cylinder pressures at  $\lambda=1,4$  in case of different “producer gas” content.

Figure 6 shows the normalized calculated heat release rate in the cylinder. It is observed that in case of all “producer gas” content the maximum heat release rate is up to 10% higher than the maximum heat release rate of natural gas.

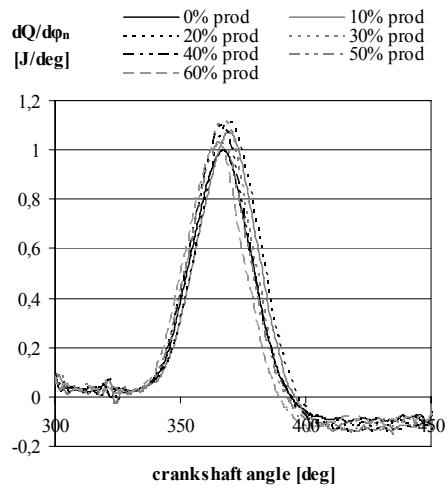

Figure 6

Calculated heat release gradient at  $\lambda=1,4$ .



To better visualise the impact of “producer gas” on heat release Figure 7 shows the normalised maximum heat release rate and Figure 8 shows the inherent crankshaft angles against the “producer gas” content of the fuel mixture in case of different excess air ratios. The base of the normalisation was the maximum heat release rate of the reference gas at stoichiometric mixture.

Figure 7 shows, that the maximum heat release rate decrease with the increase of the oxidiser (air). The decrement is non linear. Despite the decrease of the adiabatic flame temperature the increase of “producer gas” content does not involve the decrement of the maximum heat release rate at constant excess air ratio; moreover it is well observable, that in case of all “producer gas” contents the maximum heat release rate is the same or higher than the maximum heat release rate of the reference gas. However at constant excess air ratio relevant change or tendency could not be observed.

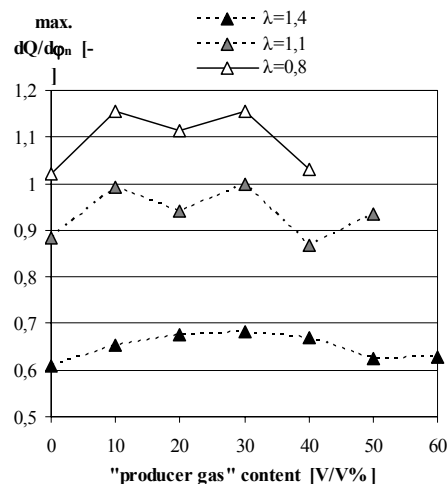

Figure 7

Maximum heat release rate against “producer gas” content at different excess air ratios

Figure 8 shows, that the location of maximum heat release rate shifts further from the TDC with the increase of the oxidiser (air). The shift is non linear. The curves are in correlation with the calculated laminar flame velocity (Figure 1).

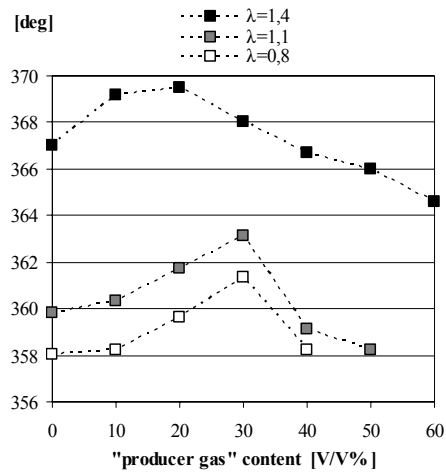

Figure 8

The location of the maximum heat release rate against "producer gas" content at different excess air ratios

As it was determined at the theoretical calculation in case of stoichiometric mixtures the change of the laminar flame velocity is not significant but shows moderate decrease until 30-40 V/V% "producer gas" content and increase above it. That is in good correspondence with the location of the maximum heat release rate, because as the laminar flame velocity decrease the location of the maximum shifts further from the TDC.

Although the LHV of "producer gas is very low due to its low  $L_0$  the heat input could be kept during the whole measuring range in case of all "producer gas" contents (Figure 9). Necessarily the consumption of the mixture needed to be increased (Figure 10).

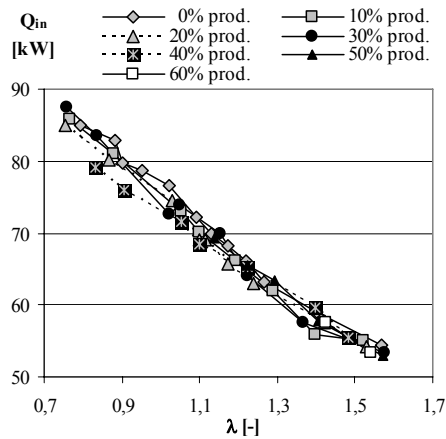

Figure 9

Heat input of different „producer gas” natural gas mixtures

It is observed that not only the consumption increases but the operation range of the engine narrows and shifts to leaner mixtures the by the increasing “producer gas” content of the mixture (Figure 10). Namely in case of 50 V/V% “producer gas” the operation range is only the two third of the operation range of the reference gas.

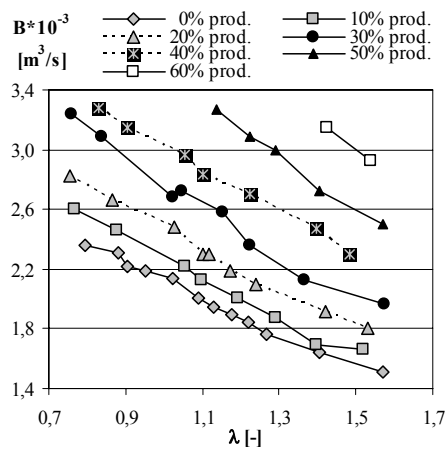

Figure 10

Consumption of different „producer gas” natural gas mixtures

Due to the increasing consumption relevant effective power change could not be experienced in the whole measuring range (Figure 11).

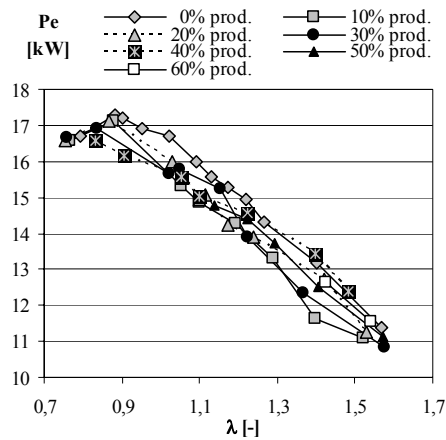

Figure 11

Effective power of different „producer gas” natural gas mixtures

The change of the effective efficiency is not relevant either, but above  $\lambda=1$  the deviation of the values is remarkable (Figure 12).

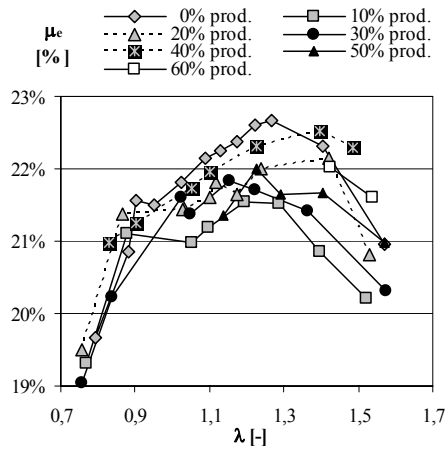

Figure 12

Effective efficiency of different „producer gas” natural gas mixtures

The results of the exhaust gas emission measurements turned out as expected [12].

Relevant change in the CO<sub>2</sub> emissions could not be observed (Figure 13). The shapes of the curves of CO<sub>2</sub> emissions are in good correspondence with the curves of power. The maximum CO<sub>2</sub> emissions are around  $\lambda \approx 0.9$  where the power maximums lay. In case of richer and leaner mixtures the CO<sub>2</sub> emission decreases.

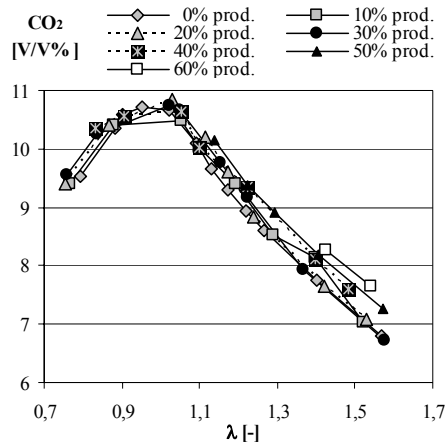

Figure 13

Measured CO<sub>2</sub> emission of different „producer gas” natural gas mixtures

In case of the determination of NO<sub>x</sub> (NO, N<sub>2</sub>O, NO<sub>2</sub>) emission only the NO emission was measured, because NO<sub>x</sub> contains more than 95% NO. Alike in case of the CO<sub>2</sub> emissions relevant change in the NO emissions could not be observed (Figure 14). The shape of the curves of NO emission is acceptable. The NO maximum are around  $\lambda = 1.1$  and decreases both in case of lower and higher excess air ratios.

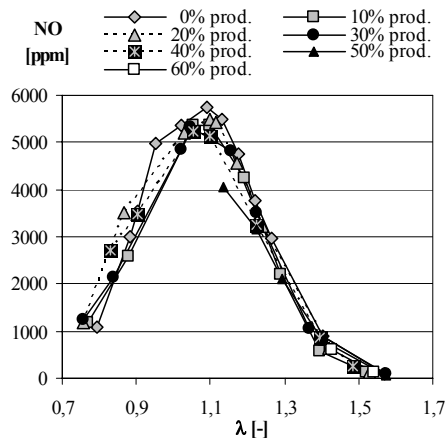

Figure 14

Measured NO emission of different „producer gas” natural gas mixtures

The change in the THC emissions is not relevant. The shape of the curves of the THC emissions is acceptable (Figure 15).

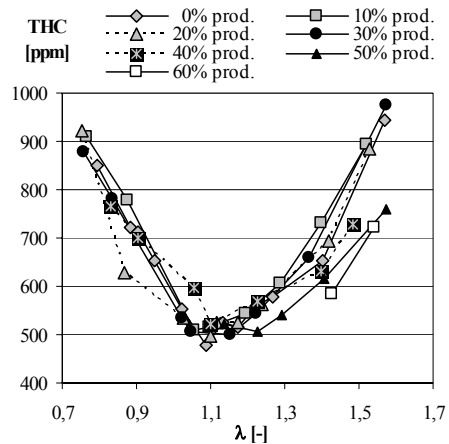

Figure 15

Measured THC emission of different „producer gas” natural gas mixtures

The minimum of THC emissions is around  $\lambda=1.1$  and they increase both in case of lower and higher excess air ratios as incomplete combustion takes place. That is in good correspondence with the NO emissions. In case of lean mixtures the THC emission slightly decrease with the increasing “producer gas” content of the fuel mixture, because due to the higher hydrogen content the flame propagation velocity increases so the hydrocarbon content of the fuel can be combusted to CO, but the combustion could not be completed due to the freezing chemical reactions.

Alike in the case of THC emission the change of CO emissions is not relevant either (Figure 16). The shape of the curves of CO emissions formed also as they were expected. In case of lean mixtures the CO emission slightly increases with the increasing “producer gas” due to the freezing chemical reactions; and in case of enriching the fuel – air mixtures the it increases considerably due to the absence of oxidizer (air) caused incomplete combustion.

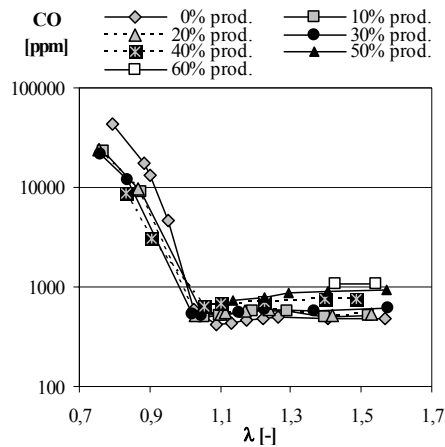

Figure 16

Measured CO emission of different „producer gas” natural gas mixtures

## Conclusions

According to previous investigations above 50% “producer gas” content power decrement and knock was expected [12].

However neither relevant change of the investigated parameters nor knock could be experienced, but due to the low LHV of “producer gas” the consumption increased.

But from the measurements of “producer gas” - natural gas mixtures can be set out that the energetic utilization of “producer gas” in IC engine with conventional build-up is limited because of the low LHV of these gaseous fuels, above a given “producer gas” content the combustion could not take place. Accordingly above 40 V/V% “producer gas” content the operation range of the engine narrows and shifts to leaner mixtures by the increasing “producer gas” content of the fuel mixture; and at the given operation conditions above 60 V/V% “producer gas” content the engine was unable to run on fuel with such high “producer gas” amount.

Therefore above 40 V/V% producer gas content and especially in case of pure pyrolysis gas operation the IC engine need to be adjusted to the used pyrolysis gas to avoid considerable losses, e.g. spark timing or the mixing unit need to be modified.

These results are in good correspondence with the others in the referred literature; however the compositions of the investigated pyrolysis gases are different in case of each researches.

## References

- [1] Laza T., Bereczky Á.: Determination of the Evaporation Constant in Case of Pure and with Alcohol Mixed Rape Seed Oil., in Proceedings of 16<sup>th</sup> International Conference in Mechanical Engineering, Brassov, May 1-4, 2008, pp. 232-237
- [2] Bereczky Á.: Utilisation of Bio Fuels in Internal Combustion Engines, in Proceedings of 8<sup>th</sup> Conference on Heat Engines and Environmental Protection, Balatonfüred, May 28-30, 2007, pp. 43-47
- [3] Meggyes A., Bereczky Á.: Energetic Analysis of Combined Gas Engine Systems, *Energetika*, 2007/3, pp. 18-22 (in Hungarian)
- [4] Nagy V., Meggyes A.: Utilization of Biogas in Gas Engines, in Proceeding of 8<sup>th</sup> International Conference on Heat Engines and Environmental Protection, Balatonfüred, 2007, pp. 95-100
- [5] Andoa Y., Yoshikawaa K., Becka M., Endo H.: Research and Development of a Low-BTU Gas-driven Engine for Waste Gasification and Power Generation, *Energy*, Vol. 30, pp. 2206-2218, 2005
- [6] Ramadhas S. A., Jayaraj S., Muraleedharan C.: Power Generation Using Coir-Pith and Wood Derived Producer Gas in Diesel Engines, *Fuel Processing Technology*, Volume 87, Issue 10, pp. 849-853
- [7] Sridhar G., Sridhar H. V., Dasappa S., Paul P. J., Rajan N. K. S., Mukunda H. S.: Development of Producer Gas Engines, in Proceedings of the Institution of Mechanical Engineers Part D – Journal of Automobile Engineering, Volume 219, Issue D3, pp. 423-438
- [8] Kovács V. B., Meggyes A.: Effect of Different Gas Compositions and Combustion Circumstances on the Operation of Heat Engines, in Proceeding of 7<sup>th</sup> International Conference on Heat Engines and Environmental Protection, Balatonfüred, May 23-25, 2005, pp. 88-94
- [9] Kovács V. B., Meggyes A., Bereczky Á.: Investigation of Utilization of Pyrolysis Gases in IC engine, in Proceeding of Sixth Conference on Mechanical Engineering, Budapest, May 29-30, 2008, CD
- [10] Lukács K.: Development of a Dual Fuels Diesel Engine System for Power Generation, Diploma, Dep. Energy Eng., BME 2007 (in Hungarian)
- [11] Kovács V. B., Meggyes A.: Investigation of Utilisation of Pyrolysis Gases in IC Engine, in Proceedings of X. Energetika-Elektrotechnika Konferencia – ENELKO, Marosvásárhely, Románia, October 8-11, 2009, pp. 93-98 (in Hungarian)
- [12] Kovács V. B., Meggyes A.: Investigation of IC Engine Utilization of Renewable Gases, Proceedings of 24. Deutscher Flammentag, Bochum, September 16-17, 2009, pp. 519-522